

# POWER REDEFINED

The wheel and telescopic wheel loaders  
8085/8095/8105/8115/8085T/8095T



**KRAMER**  
*on the safe side*





# True multitalents in every respect

Discover the all-wheel wheel loaders and telescopic wheel loaders in the 0.85 - 1.15 m<sup>3</sup> class

The premium series from Kramer has four wheel loaders (8085, 8095, 8105 and 8115) and two telescopic wheel loaders (8085T, 8095T). An optionally extended loader unit is also offered by Kramer for three of the four wheel loader models. Modern engine technology, decades of experience and know-how are also combined here in the design and development of all models of all wheel steer loaders. The Deutz engine TCD 2.9 with a capacity of 55 kW is installed as standard, which meets the current exhaust fumes level V. The models of the Kramer 8-series are true multitalents and are extremely flexible in application thanks to the large number of attachments.



## On the safe side with Kramer

Rich in tradition, the Kramer brand has been established on the market for many years and in particular stands for one value: **Safety**. The high quality of the innovative machines is only one aspect of this. As a company, Kramer is also a reliable choice for customers and dealers because the experience and innovative power of the company ensures for investment and future security. In short – you are always on the safe side with Kramer: **“Kramer – on the safe side!”**

➔ ON THE SAFE SIDE

## Table of contents

### Vehicle structure

One-piece vehicle frame  
Advantages at a glance  
Types of steering

04

### Wheel loaders and telescopic wheel loaders at a glance

Wheel loader: 8085, 8095, 8105, 8115  
Telescopic wheel loader: 8085T, 8095T

08

### Machine components

Quickhitch systems  
Loader units  
Hydraulic

10

### Cabin concept

Setup  
Equipment  
Operating elements

14

### Drive train and rear

Engines  
Travel drive system  
Approval as a tractor (EC tractor)

16

### Machine Highlights

Engines  
Drive system  
Hydraulic

22

### Accessories

Attachments  
Tyres

24

### Technical Data and Dimensions

30

#### Operating and performance data

WHEEL LOADERS AND TELESCOPIC WHEEL LOADERS	8085	8095	8105	8115
Engine output (optional) [kW]	55.4	55.4	55.4 (74.4)	55.4 (74.4)
Bucket capacity [m <sup>3</sup> ]	0.85	0.95	1.05	1.15
Bucket tipping load [kg]	3,650	3,890	4,100	4,250
Payload on pallet forks S=1.25 [kg]	2,150	2,300	2,500	2,900
Operating weight (depends on options) [kg]	4,400-5,200	4,400-5,200	4,900-5,600	5,100-5,900

	8085L	8095L	8115L	8085T	8095T
Engine output (optional) [kW]	55.4	55.4	55.4 (74.4)	55.4	55.4 (74.4)
Bucket capacity [m <sup>3</sup> ]	0.75	0.85	1.15	0.85	0.95
Bucket tipping load [kg]	3,000	3,240	4,300	3,300	3,500
Payload on pallet forks S=1.25 [kg]	2,000	2,000	2,900	2,000	2,300
Operating weight (depends on options) [kg]	4,400-5,200	4,400-5,200	5,100-5,900	4,900-5,600	5,100-5,900



# Why split what belongs together?

## Kramer – A unique system

The Kramer brand stands for all wheel steer loaders, telescopic wheel loaders and telehandlers with extreme manoeuvrability, all-terrain mobility and high efficiency. The wheel loaders impress with their high level of stability thanks to the time-tested and proven, one-piece vehicle frame.

Due to this special vehicle setup, there is no shifting of the centre of gravity through steering movements. Only the wheels move when steering due to the Ackermann steering. Thus, high stability is given even with a tight turning circle, on uneven ground conditions and with maximum payloads.

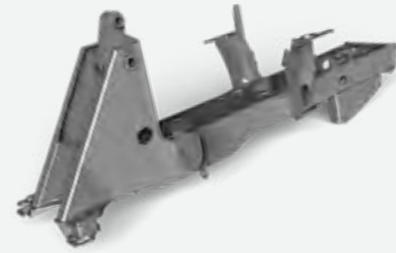

## The benefits at a glance

### High level of stability

The wheel loaders are designed with a one-piece chassis that prevents shifts in the centre of gravity –even with a full steering lock. This makes the vehicles with a high level of stability convincing – even in uneven ground conditions.

### Enormous manoeuvrability

The all-wheel steering and the steering angle of 40 degrees on the front and rear axle allow you a high degree of manoeuvrability. Some steering manoeuvres therefore become unnecessary, resulting in shorter cycle times.

### Constant payload

The undivided chassis prevents the distance between the counterweight and the loader unit from changing. The result: Constant leverage that makes working safe in all load situations. In the process, the payload always stays the same, self-contained of the steering angle.

### Undivided chassis for a high level of stability...

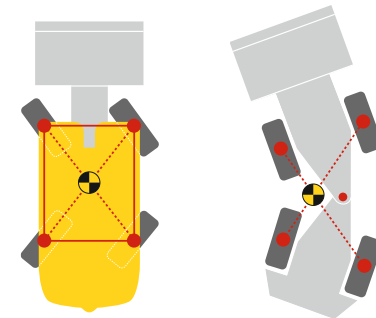

...without a shift in the centre of gravity.

### Turning made easy with all-wheel steering...

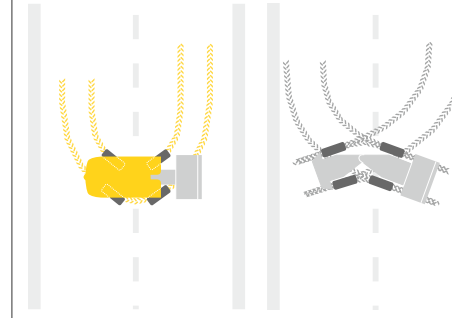

...instead of time-consuming manoeuvring with an articulated joint.

### Constant leverage for constant payload

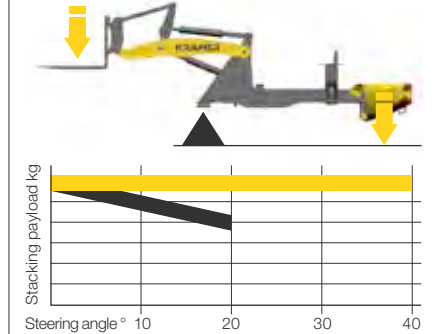

■ Kramer  
■ competition (articulated)



## Flexibility in application

### The right type of steering system for any application

The undivided vehicle frame forms the basis for three different types of steering. A wheel loader's design principle decides how it is used and for which application areas. The steering system is the crucial factor here. It is possible to change the steering type while driving Kramer wheel loaders and telescopic wheel loaders.



#### All-wheel steering

- 2 x 40 degree steering angle on the front and rear axle ensure quick work processes
- Optimised routes
- Tight turning circle



#### Front wheel steering

- Safe and familiar road travel at high speed
- Easy guidance of special attachments
- Familiar steering system
- Ideal for trailer operation

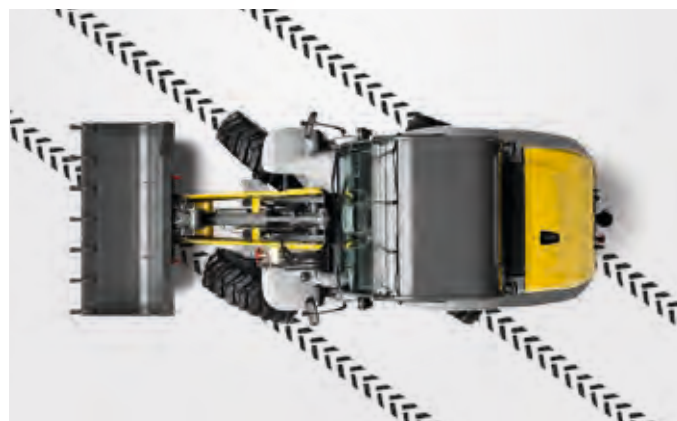

#### Crab steering

- Manoeuvrability in the smallest space
- Precise positioning in the tightest conditions
- Moving of special attachments
- Easily move away from walls and trenches



All-wheel steering is particularly manoeuvrable in tight spaces

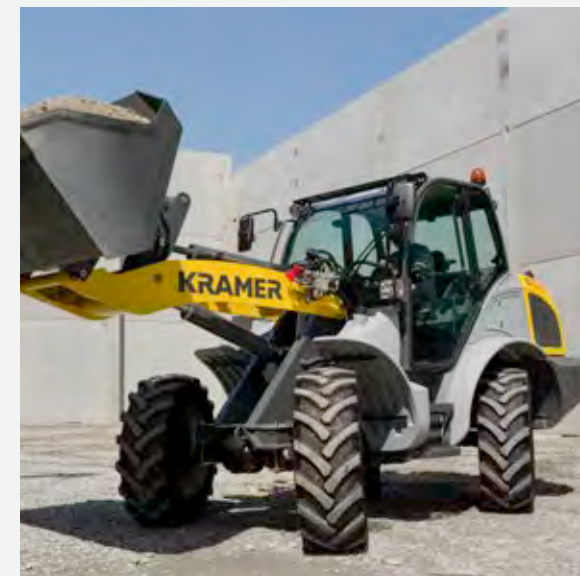

Crab steering for manoeuvring in the tightest of spaces



Front axle steering for increased stability during quick transport trips



## Just make the right choice

### Discover the product range of the 8-series

#### The wheel loaders: 8085, 8095, 8105, 8115

Thanks to their combination of constant payloads, the unbeatable manoeuvrability, the dynamic 4 wheel drive and the low operating weight, they are the all-purpose weapon on any construction site. Whether shovelling, milling, stacking, pushing or sweeping, wheel loaders can take care of various tasks and convince through high efficiency and machine utilisation. In addition, work processes are shortened by the compatibility with numerous attachments. Kramer 8-series wheel loaders are designed for the highest loads and applications under harsh conditions and prove themselves with their advanced technology and quality.



Technology, performance and comfort: The Kramer wheel loaders set standards.

#### The telescopic wheel loaders: 8085T, 8095T

The telescopic wheel loaders from Kramer are full-fledged wheel loaders with extra reach, stacking and dumping height. The telescoping loading facility reaches even greater heights and distances safely and precisely. Not only do they open up new possibilities, but they can also improve existing work processes decisively. This significantly improves productivity and economic efficiency.



**Top performance of telescopic wheel loaders:**

**+ 58% dumping height**

e.g. for loading high-sided lorries or enclosures

**+ 45% loading height**

e.g. for loading or unloading all kinds of trailers and trucks

**+ 48% stacking height**

e.g. for filling high racks





# Kramer quickhitch systems

## Attachment changing made easy

For more productivity, efficiency and safety, Kramer offers two different quickhitch systems for the respective application. Since 1963, the Kramer quickhitch plate has been a part of the standard equipment for our wheel and telescopic wheel loaders, and to date has been one of the best and most effective systems. Widespread approval forms the basis for further development, which has now resulted in the fully hydraulic quickhitch system Smart Attach. The dimensions of both quickhitch systems are identical, so existing attachments can continue to be used. Even the hydraulic attachments to date can be equipped with the new Smart Attach system.

	Attachment "Standard"	Attachment "Smart Attach"
Quickhitch system "Standard"	✓	✓
Quickhitch system "Smart Attach"	✓	✓

**Fully compatible** both attachments and quickhitch systems.



# Fully hydraulic quick change plate "Smart Attach"

## More productivity and safety

**Seconds faster attachment change\*** without manual coupling process for hoses for hydraulic attachments.

**EC declaration of conformity** for the machine and attachments.

**Easy operation**  
Hydraulic attachments are comfortably and safely coupled from the cabin without needing to enter and exit.

**High functional safety**  
Problem-free coupling of attachments, which have got warm in the sun and are under severe pressure.

**Consistent performance values** for load-over, stacking and dumping heights as well as stacking payload and bucket tipping load.

**Environmental protection** thanks to the prevention of oil leaks when coupling hydraulic attachments.

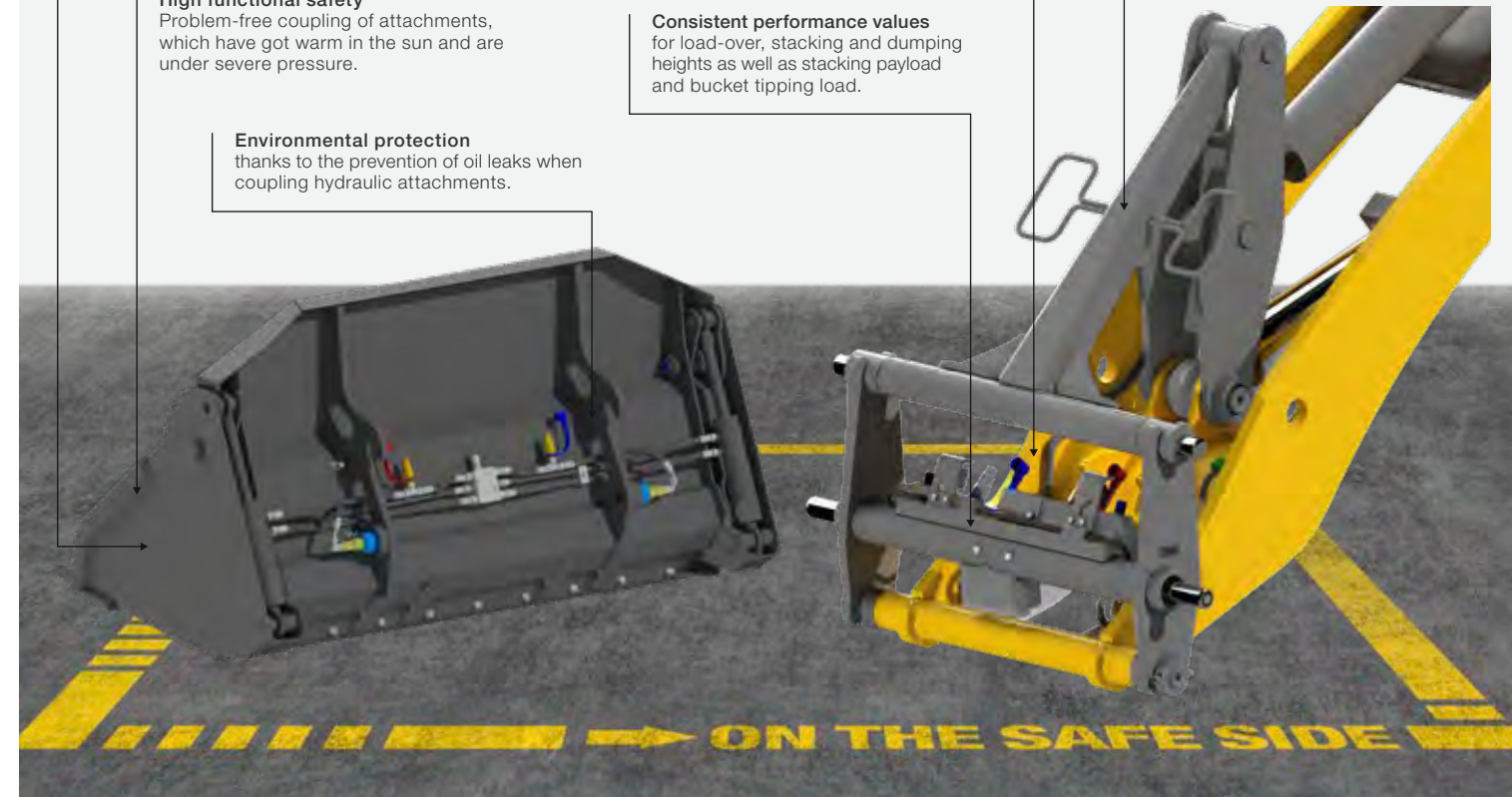

**2.5 min x 10 coupling processes per day x 220 working days x 30 €/hr = 2,750 € per year \***

\* Example calculation: savings per year with Smart Attach (2.5 min = time-save per attachment change when compared with the standard Kramer quickhitch system "Standard")

### Kramer quickhitch system "Standard"

With the hydraulic quickhitch system, the switching of tools can be easily executed from the cab. The lock pin is closed by using the touch slide on the joystick. When changing the attachments with the hydraulic auxiliary function, it is necessary for the operator to exit to manually couple the hoses.



### Kramer quickhitch system "Smart Attach"

Smart Attach is a hydraulic quickhitch system developed by Kramer, which is combined with an automatic coupler system. Manual plugging of hydraulic hoses is not required and the operator no longer needs to leave the machine. Operation is as follows directly from the cab using the joystick.





## Three loader units

### Work easily with large loads

Depending on requirements, three different loader units are available. The automatic load stabiliser is optionally available. The load stabiliser dampens oscillations of the load stabilizer, providing optimal comfort for man and machine. The automatic function automatically switches on the load stabiliser after a speed of 15 km/h (transport operation) or automatically switches it off under 13 km/h (loading operation). In addition, it is possible to continuously enable or disable the load stabiliser for certain applications.

**The load stabiliser dampens oscillations** of the load stabilizer, providing for improved ride comfort and increased driving safety.



#### Standard loader unit (P-kinematics)



The parallel-guided loader unit ensures constant lift capacity and a safe operation in materials handling. Due to the 50° high tilt back angle and the tilt-out angle of 45°, the wheel loader does not lose any material in bucket application, even when it is very full, allowing for a complete emptying of the bucket.

- Precise and safe working possible
- High tear-out forces
- Precise parallel guidance over the entire lift height

#### Extended loader unit (P-kinematics)



Specific customer wishes can be met even more flexibly due to the extended loader unit. Among other things, the range, payload and lift height change compared to the standard loader unit.

- Optimal view of the quickhitch facility and the attachment
- Increased lift height
- Extension of the loader unit by 260 mm (0.85 - 0.95 m<sup>3</sup> - class)

#### Telehandler system (Z-kinematics)



The view of the attachment is exceptional thanks to the compact modular design of the telehandler system. The advantages of Z-kinematics: In the case of equal size cylinders, dumping in a bucket creates a higher tearout force since pressure is applied to the piston side of the hydraulic cylinder when filling the bucket.

- High tear-out forces
- Good view of the quick coupler frame and the attachment
- Additional load-over and stacking height as well as range and dumping width

## Powerful hydraulics

### For sensitively controlling the machine

Connect and disconnect different attachments, sensitive control, quick work cycles and all of this with a low noise level in the cab: The technology behind the work hydraulics of our machines makes this possible.

The work hydraulics are powered by powerful gear pumps, which ensure quick work cycles of the loader unit and allow for the operation of special attachments via the 3rd control circuit, if necessary with continuous function.

#### Pressure release of 3rd control circuit:

Easily couple and uncouple attachments with hydraulic additional function



## Powerflow

The wheel loaders are impressive with their optional powerflow auxiliary hydraulics. The hydraulics are of a compact construction located on the left side of the loader unit, ensuring perfect visibility of the attachment. Whether working with a snow blower, a mulcher or even a concrete mixing bucket - the wheel loaders with the Powerflow function are extremely versatile and suitable for use in any application, all year round.



Concept solution for system module	8085	8095	8105	8115	8085T	8095T
3rd control circuit [l/min]*	70	70	84	84	70	84
Rear control circuit [l/min]*	38	38	38	38	38	38
Power flow performance hydraulics [l/min]*	115	115	120	120	115	120

\*max. Pump values



#### Top performance of the work hydraulics:

- convenient operation of attachments, even with several hydraulic functions, via the joystick
- more power to the drive system from hydraulic attachments through Powerflow
- pressure release of 3rd control circuit and proven (fully-) hydraulic quick change plate
- hydraulic oil cooler for the long-time application during power operation



## Everything under control inside

### Everything in view outside

The 8-series offers even more comfort, ergonomics and functionality. From the operator's seat to the steering wheel, all detail where consequently aligned with the needs of the operator. The result is an extremely spacious cabin with a great deal of space with a very good all-round visibility.

The all-in-one joystick, as the heart of the machine, provides secure and intuitive operation. In addition, the colour-coded switches provide an extra degree of clarity and user friendliness. With the suspended sensitive brake-inch and gas pedal, the machine's movements are always extremely precise to control. The cabin comfort is completed with a flexible steering wheel and seat adjustment as well as their ergonomic design. Both contribute to a fatigue-free working over many hours.

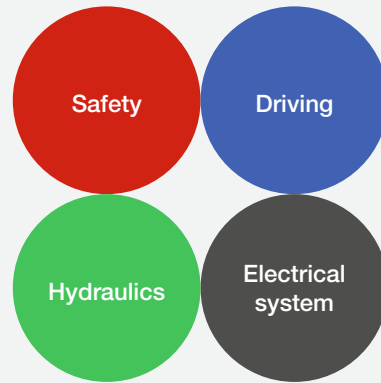

Colour-coding of the switches:  
four colours for even more safety.



Very spacious and perfect visibility to all sides

## Technical highlights

### Simple operation – Innovative cabin design

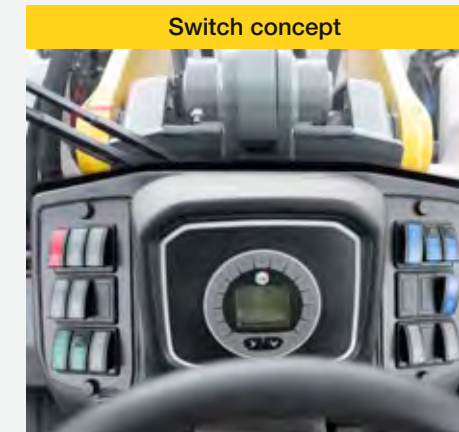

The respective functional group is very quick and easy to identify due to the colour-coded switches. Red = safety, green = hydraulics, blue = travel and grey = electrical system. This ensures the operator a convenient and safe operation without the risk of being confused. The result is increased working efficiency for the operator.

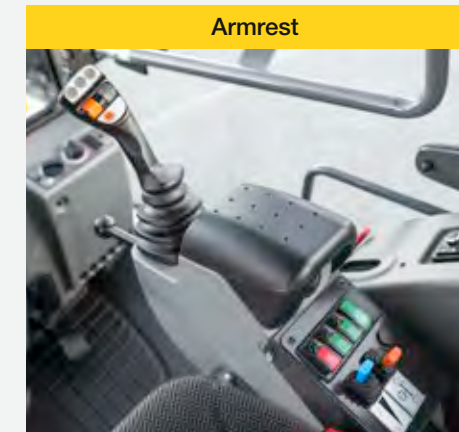

The armrest and the intuitive joystick are equipped with the most important operator's controls. This way, the operator always has the relevant functions and monitoring tools in view. The hydraulically pilot operated joystick allows for sensitive and precise control of the machine. The armrest folds up, making it possible to comfortably exit to the right.

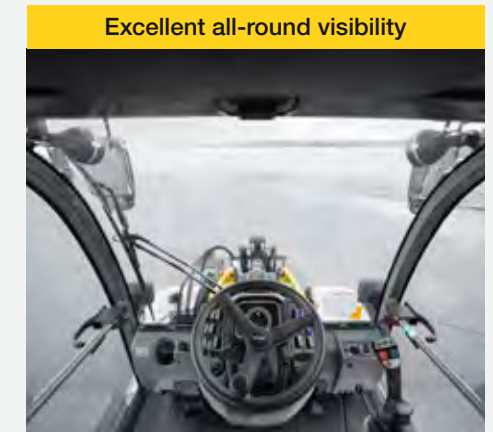

The central seat position in combination with the large glass windows offer a 360° all-round visibility. The particularly clearly-arranged design and the seat position of the operator avoid "blind spots". You can even see everything to the rear. The elevated front window allows for a perfect view of the attachment, even when the telehandler unit is extended.



The cabin can be accessed on both sides through large entry areas. The right cabin door is thus completely usable. This allows the operator to safely enter and exit on the side facing away from traffic. An interior lighting with a door contact switch is also available.

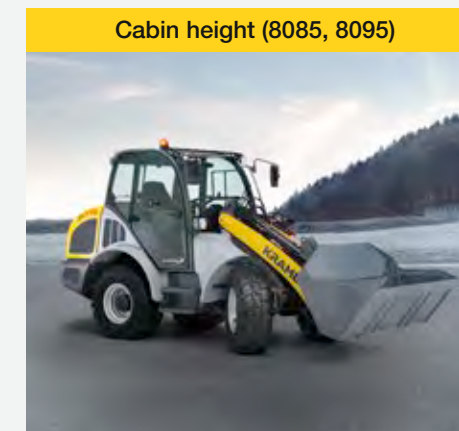

The compact and low design of both wheel loaders 8085 and 8095 of less than 2.50 metres allows operators to quickly and easily move the machines from site of application to site of application. The overall height of the machines remains under four metres during transport. The optional air-conditioning system also affects the vehicle height.



The suspended pedals with the combined brake-inch pedal allow for precise manoeuvring, even at high engine speed. The height and tilt-adjustable steering wheel offers the operator great operating comfort. The powerful heater with window ventilation and heating nozzles in the footwell ensures comfortable working, even on cold days. A fully integrated air-conditioning system is optionally available.



# Powerful engines

## For every application

You are well-prepared for strict exhaust standards with the engines of the Kramer wheel loaders and telescopic wheel loaders. The engines of the 8-series meet the current exhaust emission stages V.

The standard installed 55.4 kW engine has a dieseloxydation catalytic converter (DOC) and diesel particulate filter (DPF). In addition, the engines offer full performance despite a low RPM and a high torque increase.

For the models 8105, 8115 and 8095T, a 74.4 kW (100hp) engine with DOC, DPF and SCR technology is optionally available. The proportion of nitrogen oxides is significantly reduced by the SCR (selective catalytic reduction).

### Top performance of the engine:

- high-torque and economical engines from Deutz with current exhaust emission stage V
- the latest exhaust after-treatment with DOC + DPF
- optional 74.4 kW engine with DOC + DPF + SCR

Overview of engines	8085	8095	8105	8105	8115	8115	8085T	8095T	8095T
	Standard	Standard	Standard	Option	Standard	Option	Standard	Standard	Option
Engine manufacturer	Deutz	Deutz	Deutz	Deutz	Deutz	Deutz	Deutz	Deutz	Deutz
Output [kw/hp]	55.4/75	55.4/75	55.4/75	74.4/100	55.4/75	74.4/100	55.4/75	55.4/75	74.4/100
Exhaust after-treatment system	DOC+DPF	DOC+DPF	DOC+DPF	DOC+DPF+SCR	DOC+DPF	DOC+DPF+SCR	DOC+DPF	DOC+DPF	DOC+DPF+SCR
Exhaust emission stage (EU-emissions directive)	Stage V	Stage V	Stage V	Stage V	Stage V	Stage V	Stage V	Stage V	Stage V

### Exhaust fume aftertreatment systems

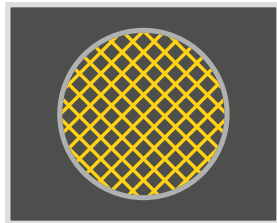

#### Diesel oxidation catalytic converter (DOC)

Catalytic converters are used these days to reduce emissions in many cars and lorries. The diesel oxidation catalytic converter has the same functionality. Without the movement of mechanical parts, it triggers chemical processes that reduce emissions.

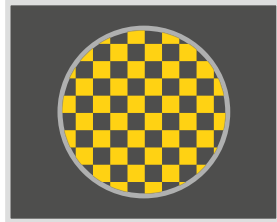

#### Diesel particulate filter (DPF)

The diesel particulate filter is used in connection with an oxidation catalytic converter to remove most of the nitrogen oxides, soot particles and non-combusted hydrocarbons from the combusted diesel fuel. The diesel particulate filter contains a porous honeycomb structure that catches the soot when it passes through. When the soot has accumulated to a certain extent, the machine's electronic system triggers fuel injections, which brings the non-combusted fuel into the oxidation catalytic converter, which is located before the filter. There it triggers an exothermic reaction that heats the exhaust fumes so much that the soot in the diesel particulate filter is combusted. This process is also known as regeneration.

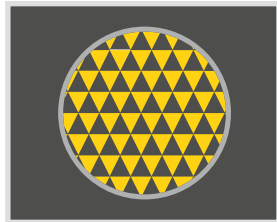

#### Selective Catalytic Reduction (SCR)

SCR technology reduces nitrogen oxides in exhaust fumes. For this purpose, a chemical reaction is required that is triggered by a urea-water solution in the SCR catalytic converter: Ammonia reacts there with the nitrogen oxides to form the harmless products of water and elemental nitrogen. This solution reduces the emission of nitrogen oxides by up to 90 per cent.



Improved running smoothness: Economical and powerful engines in all Kramer models.

Performance curve of the Deutz TCD 2.9, 55.4 kW, Stage V (standard)

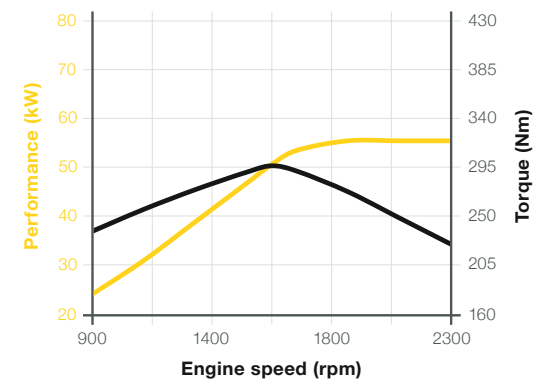

Performance curve of the Deutz TCD 3.6, 74.4 kW, Stage V (option)

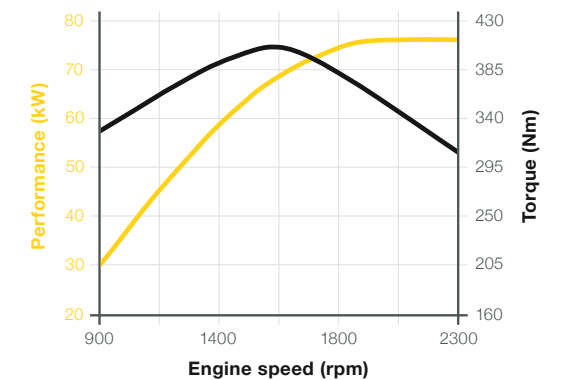



# Variably economical

## The Kramer high-speed gearbox



Optimized tractive force, minimised fuel consumption and reduced noise emissions are only some of the advantages of the variable and hydrostatic high-speed gearbox ecospeed developed by Kramer, which is optionally available with the wheel loader and telescopic wheel loader 8-series.

Via an electronic control module, the transmission is automatically adapted to the respective load condition of the machine. So you can always rely on maximum pushing power. A big plus for applications that occur day after day when loading and unloading lorries and also a gain in comfort and time that pays for itself from the beginning. This allows the machine speed to be adjusted steplessly up to a top speed of 40 km/h. Due to the approval as an EC tractor, the end user can transport up to 14 tonnes of trailer load to the site of application using public roads.



### Smart Driving - RPM reduction

When the maximum speed is reached, the intelligent engine speed reduction "Smart Driving" adjusts the engine speed to the performance requirements of the traction drive. This minimizes noise, fuel consumption and the load on individual components. The diesel engine speed can be reduced to up to 2,000 rpm depending on the selected speed version.

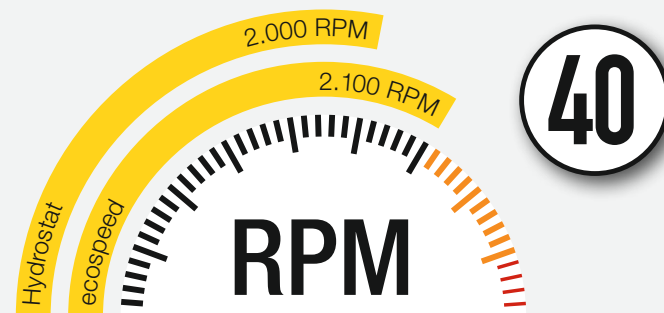

### Top performance of the drive system:

- maximum pushing power and tractive force in all driving and working situations
- smart Driving - reduced fuel consumption
- ecospeed - variable hydrostatic high-speed gearbox
- constant Speed Drive (CSD) with memory function
- 100 % connectable differential lock for constant maximum traction

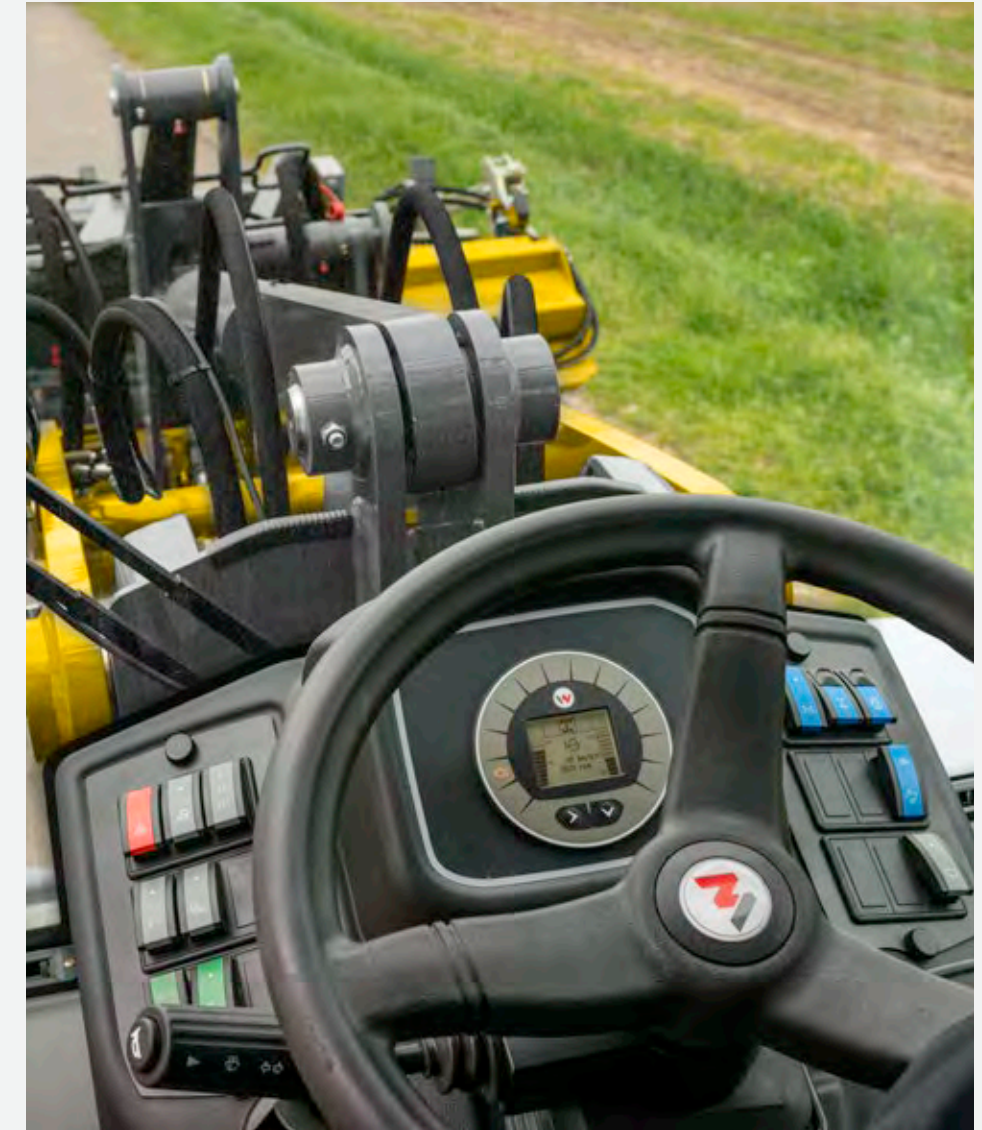

**CSD - constant travel speed:** Supports compliance with the set speed, especially when running attachments where a consistent speed is required for the correct execution of the work process, such as: Snowblower protection, rotary sweeper or mulcher.

### Two freely selectable speed levels

The speed levels can be easily changed while driving. The change occurs conveniently through a switch on the dashboard. The symbol is shown immediately in the central digital display.

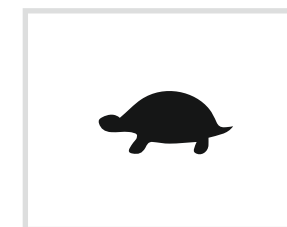

**Turtle: 0 - 10 km/h**

- Available with
- hydrostat
  - ecospeed

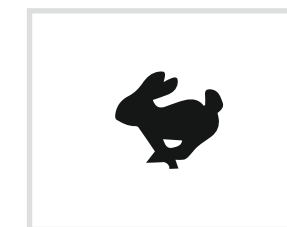

**Hare: 0 - 20 (30 / 40 km/h)\***

- Available with
- Hydrostat (maximum speed 20 km/h)
  - ecospeed (maximum speed 20, 30 or 40 km/h)

\* High-speed engine



# Approval as a tractor (EC tractor)

## More possibilities

The ball hitch in conjunction with a tractor approval (both optional) makes every wheel loader and telescopic wheel loader the perfect towing vehicle.. In this way, you can transport work machines, tools, building materials and attachments on site – even on public roads. This saves you valuable time and therefore also costs.

In trailer mode, sufficient front ballasting must be provided in addition, depending on the trailer load and coupling type. You can find more information at your Kramer distributor.



### Top performance as a tractor:

- height adjustable ball hitch
- up to 14 t trailer load in combination with pneumatic brake system and optional engine\*
- EU-wide tractor approval for use on public roads

\* The regulations and laws of the relevant countries and regions are to be met.



**European type approval:** Due to the approval, the 8-series can be put to use across the whole of Europe as a tractor.



**Ideal for a wide range of applications:** The height of the ball hitch can be adjusted.

Maximum permissible trailer loads	8085	8095	8105	8115	8085T	8095T
Coupling Type	Bolt/ Ball joint	Bolt/ Ball joint	Bolt/ Ball joint	Bolt/ Ball joint	Bolt/ Ball joint	Bolt/ Ball joint
Trailer load without brakes [kg]	750	750	750	750	750	750
Trailer load with brakes [kg]	8,000/ 3,500	8,000/ 3,500	8,000/ 3,500	8,000/ 3,500	8,000/ 3,500	8,000/ 3,500
Trailer load with air brake system [kg]	-	-	14,000/-	14,000/-	-	14,000/-



# Machine highlights at a glance

## Sturdy on the outside and intelligent on the inside

The premium series from Kramer is equipped with many details, which focus on three key aspects: Power, safety and comfort. Meeting the current exhaust emissions level, the selection of loader units, powerful hydrostat transmission and the exit on the side facing away from traffic are just a few examples of this. See for yourself.

**Comfort cabin**  
with an entry on both sides as well as extensive glazing for the best 360° all-round visibility and fatigue-free working.

**Excellent performance values**  
with compact dimensions and low net weight.

**Powerful engines**  
with current exhaust emissions level V, high power delivery and low noise levels.

**Height-adjustable trailer coupling**  
for various applications.

**Variable drive system**  
– optionally up to 40 km/h –  
for precise working and high pushing power.

**Large selection of tyre options**  
for a wide range of application areas.

**Unique steering system with three steering modes**  
all-wheel, crab steering and front-wheel steering.

**Gentle retraction and extension**  
thanks to the final position dampening in the retract and extension.

**More efficiency**  
due to the hydraulically activated quick-hitch system and parallel guided loading system with Z-kinematics for telescopic wheel loaders.

**More reach and lift height**  
due to a telescoping loader unit.

**Flexible in application**  
with a 3rd control circuit. Optionally, a 4th control circuit and the Powerflow high-performance hydraulics are available.

**Efficient working**  
thanks to the hydraulically activated quick-hitch system, load stabiliser and parallel guided loading system with P-kinematics for wheel loaders.

**High bucket apron,**  
long bucket bottom as well as a large tilt in and tilt back angle for a safe and quick material transport.

**Excellent traction**  
thanks to 100% connectable differential lock.



# A variety of tasks

## Always the right attachments











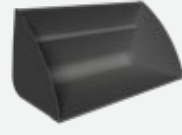

Regardless of what challenges your application holds for you: With the different attachments, you will always have a handle on the situation. Thanks to the hydraulic quickhitch system, you can adapt your Kramer wheel loader to any situation in no time. Standard attachments can even be changed in less than 10 seconds.

The attachment is based on your needs. You can find out more about our attachments at: [www.kramer.de/attachments](http://www.kramer.de/attachments)

Rapid  
attachment  
**change  
over!**



## Product range of attachments

			
Pallet fork	Pallet fork, fold-down	Pallet fork, hydraulic parallel adjustment	Standard bucket with rip-out teeth
			
Standard bucket without rip-out teeth with screwed-on blade	Bulk material bucket	Power grab bucket with rip-out teeth	Power grab bucket without rip-out teeth
			
Side swing bucket	High tip bucket	Material slide	Rotary sweeper
			
Snowplough model A	Snowplough model B		

Exact specifications and availabilities of attachments vary by model and country. Your competent Kramer dealer will be happy to help you.

### Original Kramer attachments turn your machine into an all-rounder

In combination with a suitable attachment, you can achieve maximum productivity with your machine. With a Kramer attachment, you can be sure that you will be able to use the full power of our wheel loaders, because:

- Vehicle and attachment are perfectly matched to each other
- Everything comes from a single source, so all necessary approvals and registrations are available
- With a well thought-out design with many technical details, the attachments are robust and durable



## Tread product range



- high running performance
- high level of traction
- good mobility on soft ground
- good self-cleaning

Construction machine profile



- smooth running on the road
- good traction
- particularly well-suited in sand and gravel
- good resistance

Multipurpose profile



- high level of protection from impact and cutting damage
- high lift capacity
- excellent stability and improved driving comfort
- good traction
- high running performance

Multipurpose profile



- good self-cleaning
- good track guiding
- high level of driving safety

Traction tread diagonal



- smooth running on the road
- very good self-cleaning
- optimal in muddy terrain and on loamy ground

Traction tread radial



- for uses on and off of the road
- noise-optimised
- high running performance
- good winter serviceability

Municipal profile



- smooth running on the road
- good traction
- very good winter serviceability
- good resistance

Municipal profile

Choosing the right tyres is crucial when it comes to using your wheel loader. Exact tyre specifications and availabilities vary by model and country. Your competent Kramer dealer will be happy to help you.



## EquipCare - telematics

### All the information in one glance

Always a step ahead, because EquipCare provides data, facts and answers to questions: Where is my machine right now, when is maintenance due and when does it make economic sense to replace wear parts? This helps you to avoid downtime and to extend the service life of your machine.

#### How does it work?

EquipCare is installed as standard on all Kramer vehicles. It contains a telematics module, which collects data from the machines and sends it to the manager or app via a cloud. Here, as the Equipcare user, you can view and assess the data.

The EquipCare Manager is the main portal for the telematics data of your vehicles and is controlled via the computer. The EquipCare app is for mobile access and keeps you informed about everything immediately, no matter where you are.

#### Your benefits:

Thanks to EquipCare, we always know where your machine is located currently. If the machine leaves a previously defined geo-zone, you will receive a notification on your smartphone or your computer. All events are shown here in detail, from the error message to the maintenance performed. All unnecessary downtime is avoided and the operating duration is precisely recorded.

The machine has recognised a problem? Notify your dealer of this on-site directly via the app and an initial remote diagnosis can be performed. Thanks to the proactive communication of your machine, you will be promptly informed about everything.

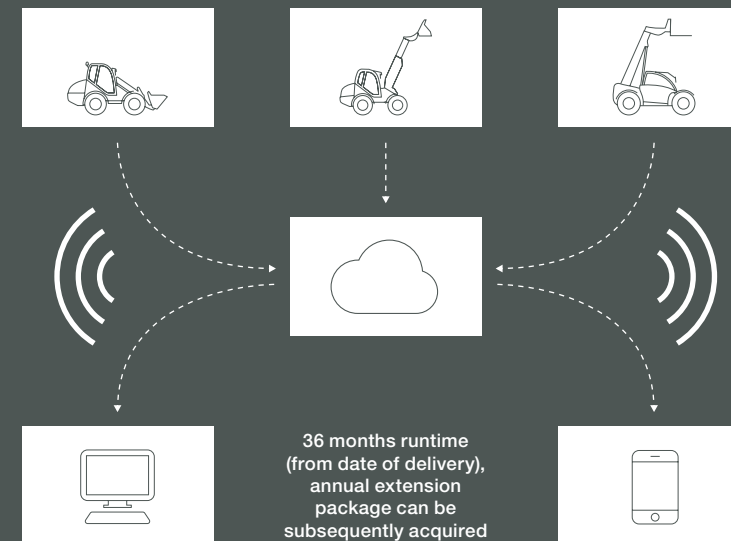

You can find more information at:  
[www.kramer.de/equipcare](http://www.kramer.de/equipcare)

SCAN NOW!



## EQUIPCARE

The telematics portals are accessible for you around the clock:



**EquipCare Manager:** The precise position or the GPS data of your machines can be viewed at any time in your password-protected area.

[www.kramer.de/equipcarelogin](http://www.kramer.de/equipcarelogin)

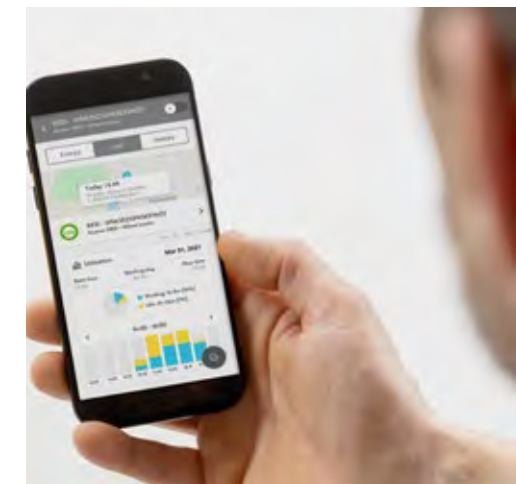

**EquipCare App:** The app provides you with a number of functions to access your machine data and information while on the go. Simply download and install the app from the Google Play Store or the Apple App Store.

◀ Go to the app



# Top-Performance

---

## Telescopic wheel loader

- extra 58% dumping height, e.g. for loading high-sided lorries or enclosures
- extra 45% loading height, e.g. for loading or unloading all kinds of trailers and trucks
- extra 48% stacking height, e.g. for filling high racks

---

## Work hydraulics

- convenient operation of attachments, even with several hydraulic functions, via the joystick
- more power to the drive system from hydraulically activated attachments through Powerflow
- pressure release of 3rd control circuit and proven (fully-) hydraulic quick change plate
- hydraulic oil cooler for long-time application during power operation

---

## Engine

- high-torque and economical engines from Deutz with current exhaust fumes level V
- the latest exhaust aftertreatment with DOC + DPF
- optional 74.4 kW engine with DOC + DPF + SCR

---

## Travel drive system

- maximum pushing power and tractive force in all driving and working situations
- smart Driving - reduced fuel consumption
- ecospeed - variable hydrostatic high-speed gearbox
- constant Speed Drive (CSD) with memory function
- 100% connectible differential lock for constant maximum traction

---

## Tractor

- height adjustable ball hitch
  - up to 14 t trailer load in combination with pneumatic brake system and optional engine
  - EU-wide tractor approval for use on public roads
-



# Technical data

Engine	Unit	8085	8095	8105	8115	8085T	8095T
<b>Make</b>	–	Deutz	Deutz	Deutz	Deutz	Deutz	Deutz
<b>Type/Model</b>	–	TCD 2.9	TCD 2.9	TCD 2.9 (standard) TCD 3.6 (option)	TCD 2.9 (standard) TCD 3.6 (option)	TCD 2.9	TCD 2.9 (standard) TCD 3.6 (option)
<b>Performance</b>	<b>kW</b>	55.4	55.4	55.4 (standard) 74.4 (option)	55.4 (standard) 74.4 (option)	55.4	55.4 (standard) 74.4 (option)
<b>Max. torque</b>	<b>Nm at rpm</b>	300 at 1,600	300 at 1,600	300 at 1,600 410 at 1,600 (option)	300 at 1,600 410 at 1,600 (option)	300 at 1,600	300 at 1,600 410 at 1,600 (option)
<b>Displacement</b>	<b>cm³</b>	2,925	2,925	2,925 (standard) 3,621 (option)	2,925 (standard) 3,621 (option)	2,925	2,925 (standard) 3,621 (option)
<b>Exhaust emission stage</b>	–	EU Stage V	EU Stage V	EU Stage V	EU Stage V	EU Stage V	EU Stage V
<b>Power transmission</b>	Unit						
<b>Travel drive system</b>	–	Automotive continuously variable, hydrostatic axial piston drive					
<b>Travel speed</b>	<b>km/h</b>	20 (standard) 30 (option) 40 (option)	20 (standard) 30 (option) 40 (option)	20 (standard) 30 (option) 40 (option)	20 (standard) 30 (option) 40 (option)	20 (standard) 30 (option) 40 (option)	20 (standard) 30 (option) 40 (option)
<b>Axles</b>	–	Planetary steering axles					
<b>Total oscillation angle</b>	°	22	22	22	22	22	22
<b>Differential lock</b>	%	100% VA	100% VA	100% VA + HA	100% VA + HA	100% VA	100% VA + HA
<b>Service brake</b>	–	foot pedal operated hydraulic disc brake					
<b>Parking brake</b>	–	hand-operated mechanical disc brake					
<b>Standard tyres</b>	–	12.5-20	12.5-20	16/70-20	405/70-24	12.5-20	16/70-20
<b>Steering and work hydraulics</b>	Unit						
<b>Steering system functionality</b>	–	Hydrostatic all-wheel steering with emergency steering properties					
<b>Functioning of work hydraulics</b>	–	Gear pump					
<b>Steering pump</b>	<b>cm³/rev</b>	32	32	36	36	32	36
<b>Steering cylinder</b>	–	One steering cylinder per axle					
<b>Steering lock max.</b>	°	40	40	40	40	40	40
<b>Work pump</b>	<b>cm³/rev</b>	32	32	36	36	32	36
<b>Max. flow rate of pump</b>	<b>l/min</b>	70	70	83	83	70	83
<b>Max. flow rate of pump optional</b>	<b>l/min</b>	115	115	120	120	115	120
<b>Max. pressure</b>	<b>bar</b>	240	240	240	240	240	240
<b>Quickhitch system</b>	–	Kramer HV/WL - C Kramer HV/WL - C Kramer HV/WL - C Kramer HV/WL - L Kramer HV/WL - C Kramer HV/WL - C					
<b>Pilot operation</b>	–	hydraulic					
<b>pilot control of 3rd control circuit</b>	–	electrical					

# Technical data

Kinematics	Unit	8085	8095	8105	8115	8085T	8095T
<b>Design system</b>	–	P-kinematics	P-kinematics	P-kinematics	P-kinematics	Z-kinematics	Z-kinematics
<b>Lifting force calculation according to ISO 14397-2 mechanical/hydraulic</b>	<b>kN</b>	43.8	43.6	44.5	46.5	31	31
<b>Tearout force calculation as per ISO 14397-2 mechanical/hydraulic</b>	<b>kN</b>	40.7	39.4	40	41.9	51	51
<b>Lift cylinder raising/lowering</b>	<b>s</b>	6.0/4.0	6.0/4.0	5.2/3.8	6.2/4.8	5.6/4.0	5.0/3.6
<b>Tilt in/tilt out tilt cylinder: (upper position of the loader unit)</b>	<b>s</b>	2.4/2.6	2.4/2.6	2.5/2.8	2.3/2.9	2.6/2.6	2.5/2.5
<b>Tilt-in / tilt-out angle</b>	°	50/45	50/45	50/42	50/45	40/40	40/40
<b>Tippling load (standard bucket) required/actual</b>	<b>kg</b>	3,650	3,890	4,100	4,250	3,300	3,500
<b>Tippling load (pallet forks)</b>	<b>kg</b>	2,685	2,875	3,125	3,625	2,500	2,875
<b>Payload (standard bucket)</b>	<b>kg</b>	1,530	1,710	2,050	2,225	1,530	1,710
<b>Capacities</b>	Unit						
<b>Fuel tank</b>	<b>l</b>	85	85	120	120	85	120
<b>Hydraulic tank</b>	<b>l</b>	50	50	64	64	50	64
<b>DEF tank</b>	<b>l</b>	-	-	10	10	-	10
<b>Electrical system</b>	Unit						
<b>Operating voltage</b>	<b>V</b>	12	12	12	12	12	12
<b>Battery/alternator standard TCD 2.9</b>	<b>Ah/A</b>	77/95	77/95	77/95	77/95	77/95	77/95
<b>Battery/alternator with optional engine TCD 3.6</b>	<b>Ah/A</b>	-	-	100/95	100/95	-	100/95
<b>Starter motor standard TCD 2.9</b>	<b>kW</b>	2.6	2.6	2.6	2.6	2.6	2.6
<b>Starter motor with optional motor TCD 3.6</b>	<b>kW</b>	-	-	3.2	3.2	-	3.2
<b>Noise emissions*</b>	Unit						
<b>Measured value</b>	<b>dB(A)</b>	100.4	100.4	100.4	100.4	100.4	100.4
<b>Guaranteed value</b>	<b>dB(A)</b>	101	101	101	101	101	101
<b>Noise level at the operator's ear</b>	<b>dB(A)</b>	77	77	77	77	77	77
<b>Vibrations**</b>	Unit						
<b>Vibration total value of the upper extremities of the body</b>	<b>m/s²</b>	< 2.5 m/s² (< 8.2 feet/s²)					
<b>Maximum weighted average effective value of acceleration for the body</b>	<b>m/s²</b>	< 0.5 m/s² (< 1.64 feet/s²)*** 1.28 m/s² (4.19 feet/s²)****					

\* Information: The measurement occurs as per the requirements of the standard EN 474 and the directive 2000/14/EC. Measuring station: Paved surface.

\*\*\* On flat and solid ground with the corresponding driving style

\*\*\*\* Application in extraction under harsh environmental conditions

\*\* Uncertainty of measurement such as stated in ISO/TR 25398:2006. Please instruct or inform the operator of possible dangers caused by vibrations.



## Technical data

8085: Standard loader unit	Unit	Standard with rip-out teeth	Bulk material	Bulk material	Power grab bucket with rip-out teeth	Side pivot	High-tipping
							
Bucket	m <sup>3</sup>	0.85	1.05	1.30	0.75	0.75	0.87
Material density	t/m <sup>3</sup>	1.80	1.50	1.20	1.80	1.80	1.60
Overall length of attachment	mm	990	950	1,020	1,080	1,030	1,160
Overall length with attachment tilted in 45° 200 mm above ground	mm	5,280	5,275	5,310	5,350	5,300	5,390
Bucket width	mm	1,850	2,050	2,150	1,850	1,844	1,880
Bucket swivel point	mm	3,290	3,350	3,350	3,350	3,350	3,350
Overhead loading height	mm	3,140	3,050	3,090	3,050	3,070	3,800
Dump height	mm	2,560	2,450	2,410	2,500	2,410	3,760
Dump reach	mm	635	660	780	610	870	960
Digging depth	mm	60	100	80	100	80	35
Weight of attachment	kg	343	429	458	532	520	508

8095: Standard loader unit	Unit	Standard with rip-out teeth	Bulk material	Bulk material	Power grab bucket with rip-out teeth	Side pivot	High-tipping
							
Bucket	m <sup>3</sup>	0.95	1.05	1.15	0.85	0.75	1.06
Material density	t/m <sup>3</sup>	1.80	1.30	0.90	1.80	1.80	1.30
Overall length of attachment	mm	1,003	945	925	1,100	1,030	1,160
Overall length with attachment tilted in 45° 200 mm above ground	mm	5,410	5,280	5,260	5,370	5,300	5,390
Bucket width	mm	1,950	2,050	2,150	1,950	1,844	1,880
Bucket swivel point	mm	3,290	3,350	3,350	3,350	3,350	3,350
Overhead loading height	mm	3,140	3,050	3,090	3,050	3,070	3,800
Dump height	mm	2,560	2,450	2,470	2,490	2,410	3,760
Dump reach	mm	635	660	690	600	870	960
Digging depth	mm	100	100	75	110	80	35
Weight of attachment	kg	362	429	453	537	520	508

## Technical data

8105: Standard loader unit	Unit	Standard with rip-out teeth	Bulk material	Bulk material	Power grab bucket with rip-out teeth	Side pivot	High-tipping
							
Bucket	m <sup>3</sup>	1.05	1.30	1.60	0.95	0.75	1.06
Material density	t/m <sup>3</sup>	1.80	1.30	1.00	1.80	1.80	1.50
Overall length of attachment	mm	1,050	1,010	980	1,220	1,030	1,255
Overall length with attachment tilted in 45° 200 mm above ground	mm	5,710	5,690	5,741	5,780	5,670	5,860
Bucket width	mm	2,050	2,150	2,300	2,050	1,844	1,850
Bucket swivel point	mm	3,360	3,330	3,330	3,330	3,330	3,330
Overhead loading height	mm	3,150	3,150	3,110	3,130	3,150	3,860
Dump height	mm	2,550	2,450	2,400	2,500	2,450	3,820
Dump reach	mm	660	800	800	660	890	1,610
Digging depth	mm	60	100	140	130	110	60
Weight of attachment	kg	425	458	503	686	520	556

8115: Standard loader unit	Unit	Standard with rip-out teeth	Bulk material	Bulk material	Power grab bucket with rip-out teeth	Side pivot	High-tipping
							
Bucket	m <sup>3</sup>	1.15	1.50	1.80	1.05	0.85	1.21
Material density	t/m <sup>3</sup>	1.80	1.30	0.90	1.80	1.80	1.30
Overall length of attachment	mm	1,090	1,030	1,200	1,290	1,040	1,220
Overall length with attachment tilted in 45° 200 mm above ground	mm	5,800	5,780	5,890	5,890	5,740	5,950
Bucket width	mm	2,150	2,300	2,300	2,150	2,044	2,050
Bucket swivel point	mm	3,450	3,440	3,440	3,440	3,440	3,440
Overhead loading height	mm	3,200	3,220	3,220	3,210	3,270	3,960
Dump height	mm	2,650	2,550	2,430	2,580	2,590	3,910
Dump reach	mm	660	800	920	770	970	1,140
Digging depth	mm	85	90	90	110	45	70
Weight of attachment	kg	497	526	573	782	590	695



## Technical data

8085T: Telescope loader unit	Unit	Standard with rip-out teeth	Bulk material	Bulk material	Power grab bucket with rip-out teeth	Side pivot
						
Bucket	m³	0.85	1.05	1.30	0.75	0.75
Material density	t/m³	1.80	1.30	0.90	1.80	1.80
Overall length of attachment	mm	990	945	1,020	1,080	1,030
Overall length with attachment tilted in 45° 200 mm above ground	mm	5,890	5,690	5,740	5,770	5,730
Bucket width	mm	1,850	2,050	2,150	1,850	1,844
Bucket pivotal point retracted/extended	mm	3,610/4,690	3,660/4,710	3,660/4,710	3,660/4,710	3,660/4,710
Load-over height retracted/extended	mm	3,440/4,520	3,450/4,500	3,480/4,530	3,445/4,495	3,470/4,520
Dumping height retracted/extended	mm	3,010/4,010	2,891/3,941	2,840/3,890	2,935/3,990	2,870/3,920
Dumping width retracted/extended	mm	620/1,080	732/1,199	842/1,309	659/1,126	946/1,413
Digging depth retracted/extended	mm	80	150	110	150	123
Weight of attachment	kg	343	429	458	507	521

8095T: Telescope loader unit	Unit	Standard with rip-out teeth	Bulk material	Bulk material	Power grab bucket with rip-out teeth	Side pivot
						
Bucket	m³	0.95	1.15	1.50	0.85	0.75
Material density	t/m³	1.80	1.30	1.00	1.80	1.80
Overall length of attachment	mm	1,003	925	1,025	1,100	1,030
Overall length with attachment tilted in 45° 200 mm above ground	mm	6,040	5,980	6,070	6,110	6,060
Bucket width	mm	1,950	2,150	2,300	1,950	1,844
Bucket pivotal point retracted/extended	mm	3,630/4,680	3,660/4,710	3,660/4,710	3,660/4,710	3,660/4,710
Load-over height retracted/extended	mm	3,400/4,450	3,470/4,520	3,470/4,520	3,440/4,500	3,460/4,510
Dumping height retracted/extended	mm	2,930/3,980	2,900/3,960	2,840/3,890	2,920/3,970	2,860/3,920
Dumping width retracted/extended	mm	640/1,100	760/1,230	840/1,130	670/1,140	940/1,410
Digging depth retracted/extended	mm	50	110	110	140	120
Weight of attachment	kg	362	454	478	557	521

## Technical data

8085L: Extended loader unit	Unit	Standard with rip-out teeth	Bulk material	Bulk material	Power grab bucket with rip-out teeth	High-tipping
Bucket	m³	0.75	0.95	1.15	0.75	0.87
Material density	t/m³	1.80	1.30	1.00	1.50	1.30
Overall length of attachment	mm	935	880	930	1,080	1,160
Overall length with attachment tilted in 45° 200 mm above ground	mm	5,600	5,490	5,560	5,660	5,700
Bucket width	mm	1,850	1,950	2,150	1,850	1,880
Bucket swivel point	mm	3,550	3,499	3,499	3,499	3,499
Overhead loading height	mm	3,400	3,340	3,320	3,280	4,020
Dump height	mm	2,850	2,790	2,720	2,750	3,980
Dump reach	mm	730	800	840	740	1,090
Digging depth	mm	30	55	90	100	35
Weight of attachment	kg	331	360	436	531	508

8095L: Extended loader unit	Unit	Standard with rip-out teeth	Bulk material	High-tipping
Bucket	m³	0.85	1.50	0.87
Material density	t/m³	1.80	0.90	1.30
Overall length of attachment	mm	990	1,025	1,160
Overall length with attachment tilted in 45° 200 mm above ground	mm	5,650	5,630	5,700
Bucket width	mm	1,950	2,300	1,880
Bucket swivel point	mm	3,550	3,490	3,490
Overhead loading height	mm	3,400	3,320	4,020
Dump height	mm	2,850	2,650	3,980
Dump reach	mm	730	920	1,090
Digging depth	mm	30	50	35
Weight of attachment	kg	344	476	508

8115L: Extended loader unit	Unit	Standard with teeth	Bulk material	Bulk material	Power grab bucket with rip-out teeth	Side pivot	High-tipping
Bucket	m³	1.15	1.50	1.80	1.05	0.85	1.21
Material density	t/m³	1.80	1.30	0.90	1.80	1.80	1.30
Overall length of attachment	mm	1,090	1,030	1,200	1,290	1,040	1,220
Overall length with attachment tilted in 45° 200 mm above ground	mm	5,800	5,780	5,890	5,890	5,740	5,950
Bucket width	mm	2,150	2,300	2,300	2,150	2,044	2,050
Bucket swivel point	mm	3,640	3,690	3,690	3,690	3,690	3,690
Overhead loading height	mm	3,430	3,470	3,470	3,450	3,520	4,220
Dump height	mm	2,970	2,920	2,820	2,930	2,980	4,170
Dump reach	mm	490	600	740	560	760	770
Digging depth	mm	85	90	90	110	40	70
Weight of attachment	kg	497	526	573	752	590	695



# Technical data

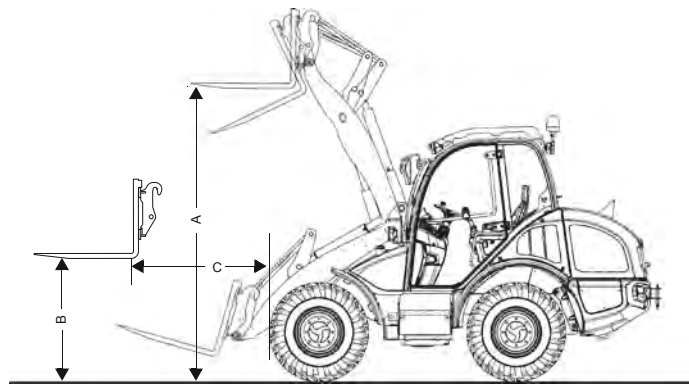

Pallet fork (load centre 500 mm)		Unit	8085	8095	8105	8115	8085T	8095T
								
-	Width of the fork carriage	mm	1,200	1,200	1,200	1,200	1,200	1,200
-	Length of the fork tines	mm	1,000	1,000	1,000	1,000	1,000	1,000
-	Tipping load of pallet fork	kg	2,800	3,050	3,200	3,500	2,550	3,000
-	Stacking payload S=1.25	kg	2,150	2,300	2,500	2,900	2,000	2,300
-	Stacking payload S=1.67	kg	1,650	1,800	1,900	2,120	1,500	1,800
A	Stacking height	mm	3,010	3,010	3,080	3,220	3,400/4,450	3,400/4,450
B	Lift height, mast horizontal	mm	1,260	1,260	1,270	1,390	1,270	1,270
-	Digging depth	mm	110	110	140	45	140	150
-	Ground reach	mm	770	770	900	740	1,130	1,130
C	Reach, mast horizontal	mm	1,170	1,170	1,250	1,250	1,480	1,480
-	Reach at max. height	mm	330	330	380	390	330/800	330/800

Pallet fork (load centre 500 mm)		Unit	8085L	8095L	8115L
					
-	Width of the fork carriage	mm	1,200	1,200	1,200
-	Length of the fork tines	mm	1,000	1,000	1,000
-	Tipping load of pallet fork	kg	2,300	2,550	3,500
-	Stacking payload S=1.25	kg	2,000	2,000	2,900
-	Stacking payload S=1.67	kg	1,350	1,500	2,120
A	Stacking height	mm	3,230	3,230	3,460
B	Lift height, mast horizontal	mm	1,260	1,260	1,390
-	Digging depth	mm	110	110	45
-	Ground reach	mm	1,090	1,080	740
C	Reach, mast horizontal	mm	1,430	1,430	1,250
-	Reach at max. height	mm	450	450	30

# Dimensions

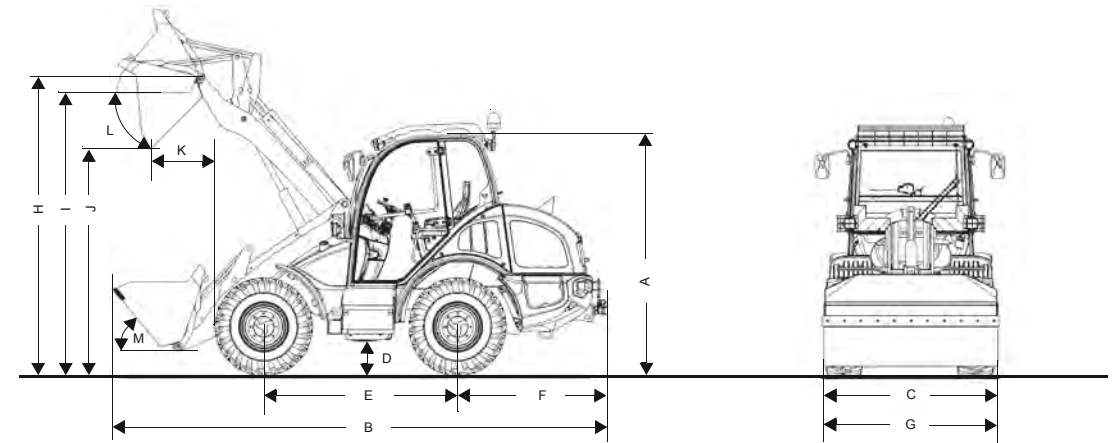

		Unit	8085	8095	8105	8115	8085T	8095T
A	Height	mm	2,490 with air-conditioning system request: 2,580	2,490 with air-conditioning system request: 2,580	2,650 with air-conditioning system request: 2,740	2,690 with air-conditioning system request: 2,780	2,600 with air-conditioning system request: 2,660	2,760 with air-conditioning system request: 2,820
B	Length	mm	5,280	5,410	5,710	5,800	5,890	6,040
C	Width	mm	1,780	1,780	1,920	1,970	1,780	1,920
D	Ground clearance	mm	330	330	350	390	330	350
E	Wheel base	mm	2,020	2,020	2,150	2,150	2,020	2,150
F	Centre of rear axle to end of vehicle	mm	1,490	1,490	1,620	1,620	1,490	1,620
H	Bucket swivel point	mm	3,290	3,290	3,359	3,450	3,615/4,690	3,630/4,680
G	Bucket width	mm	1,850	1,950	2,050	2,150	1,850	1,950
I	Overhead loading height	mm	3,140	3,090	3,124	3,200	3,445/4,520	3,400/4,450
J	Dumping height (bucket)	mm	2,560	2,580	2,621	2,650	3,010/4,010	2,930/3,980
K	Dumping width (bucket)	mm	635	650	735	660	620/1,080	640/1,100
L	Tip-out angle	°	45	45	42	45	40	40
M	Tipping angle	°	50	50	50	50	40	40
-	Turning radius Tyres	mm	2,840	2,840	2,950	3,000	2,840	2,950

		Unit	8085L	8095L	8115L
A	Height	mm	2,490 with air-conditioning system request: 2,580	2,490 with air-conditioning system request: 2,580	2,690 with air-conditioning system request: 2,780
B	Length	mm	-	-	5,800
C	Width	mm	1,780	1,780	1,970
D	Ground clearance	mm	330	330	390
E	Wheel base	mm	2,020	2,020	2,150
F	Centre of rear axle to end of vehicle	mm	1,490	1,490	1,620
H	Bucket swivel point	mm	3,550	3,550	3,640
I	Overhead loading height	mm	3,350	3,360	3,480
G	Bucket width	mm	1,750	1,850	2,150
J	Dump height	mm	2,820	2,820	3,000
K	Dumping width (bucket)	mm	790	790	500
L	Tip-out angle	°	43	43	35
M	Tipping angle	°	50	50	50
-	Turning radius Tyres	mm	2,840	2,840	3,000



# Load-bearing capacity diagram

8085T Load-bearing capacity diagram (with LSP 500mm)

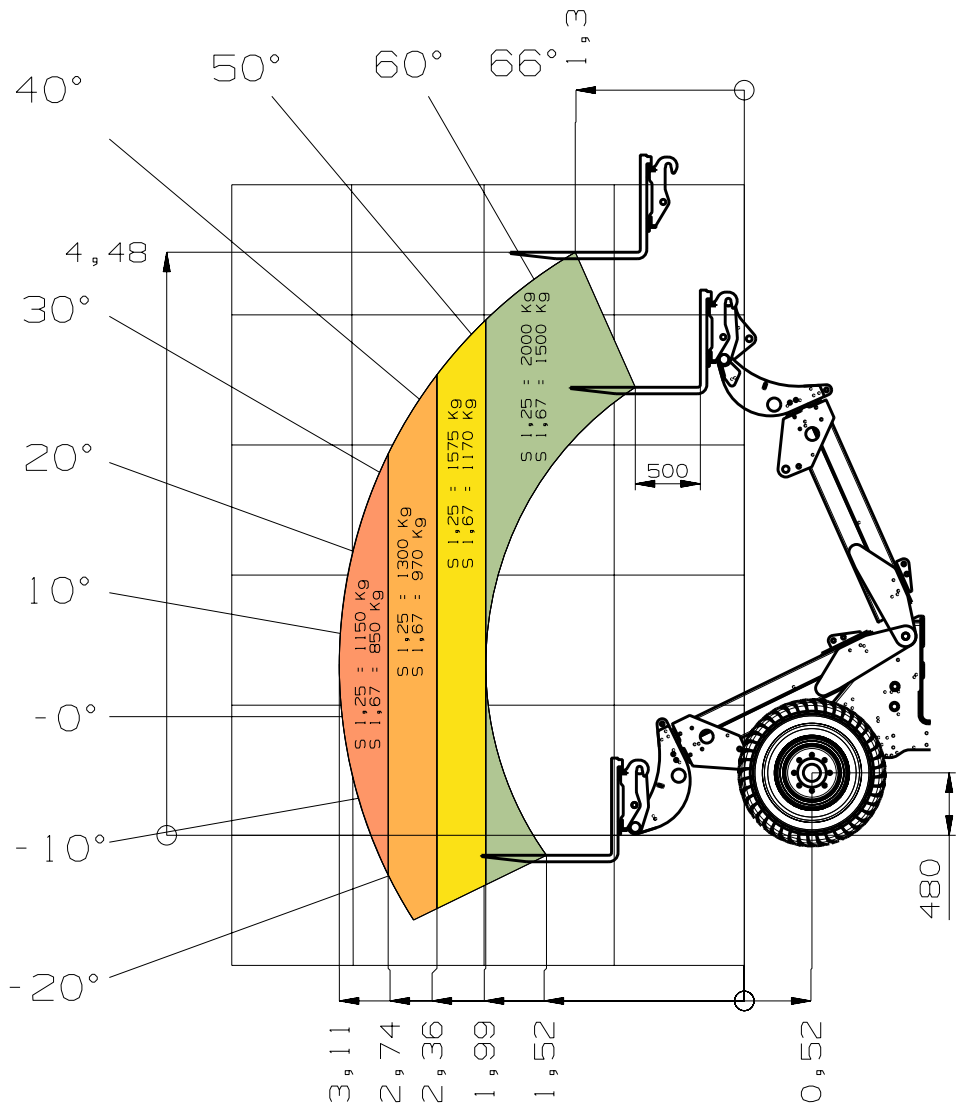

# Load-bearing capacity diagram

8095T Load-bearing capacity diagram (with LSP 500mm)

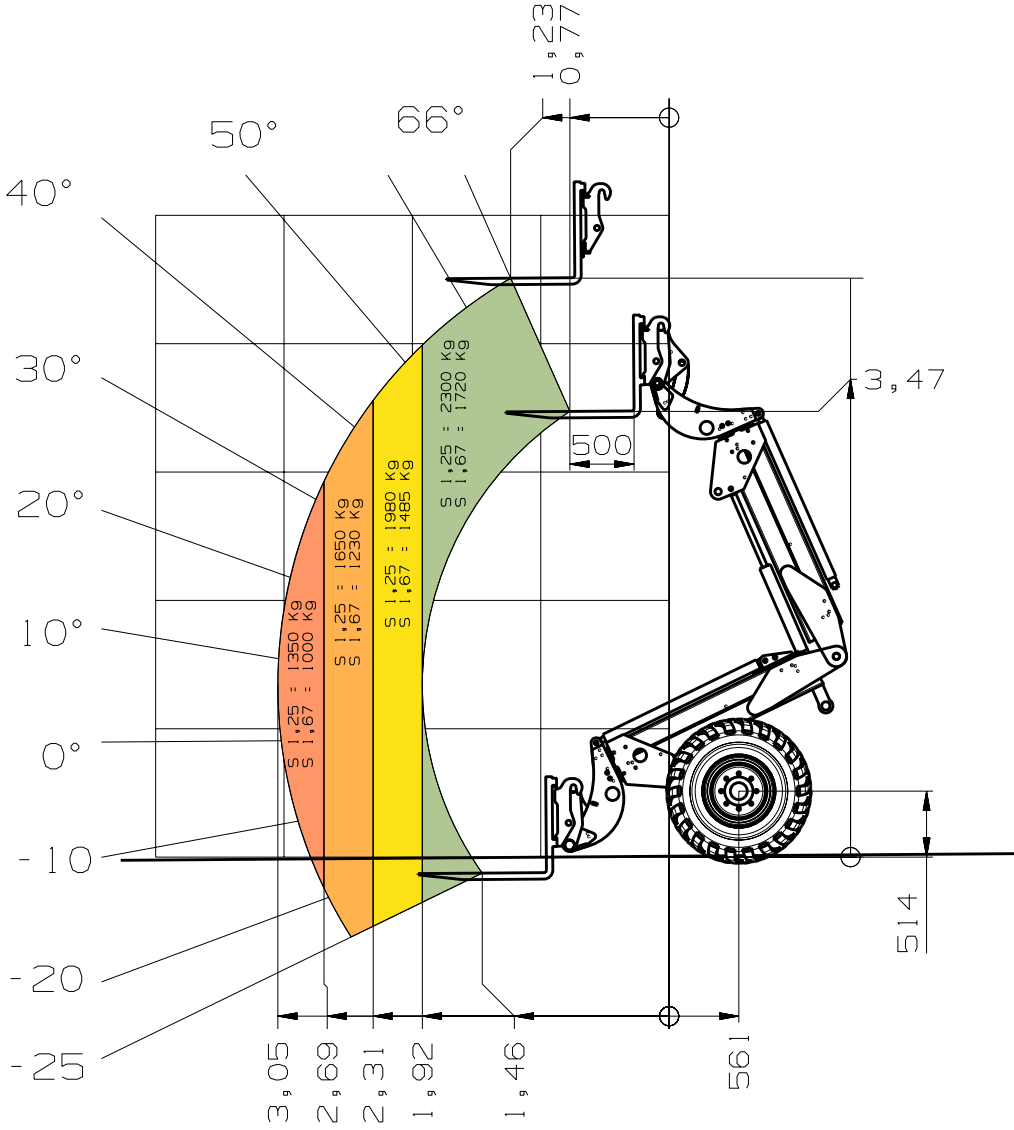





**Wheel loaders**

Bucket capacity: 0.35 - 1.80 m<sup>3</sup>



**Telescopic wheel loader**

Bucket capacity: 0.65 - 1.45 m<sup>3</sup>



**Telehandlers**

Payload: 1,450 - 5,500 kg

**Service that can be seen**

Focus on your daily activities – with our comprehensive services, we take care of the rest. We are there when you need us: capable, fast, and directly on site if necessary.



Repair & maintenance



Academy



Telematics



Insurance



Spare parts



Financial solutions

Go to Kramer  
dealer search:  
**SCAN HERE!**



KC.EMEA.10031.V05.EN-GB